

Modular Jack Sockets

Universal modular jack sockets

Ref.-no.: UMA-CAT6A-25

Mounting adapter

Ref.-no.: 69-1 .., 69-2 ..

Centre plates

Ref.-no.: ... 1569-1 PL .., ... 1569-2 PL ..,
.. 1969-1 PL .., ... 1969-2 PL ..

Smart TV sockets

Ref.-no.: MMD .. 4521 ..

ALBRECHT JUNG GMBH & CO. KG

Volmestraße 1
58579 Schalksmühle
GERMANY

Tel. +49 2355 806-0
Fax +49 2355 806-204
kundencenter@jung.de
www.jung.de

03/2024
0024075404

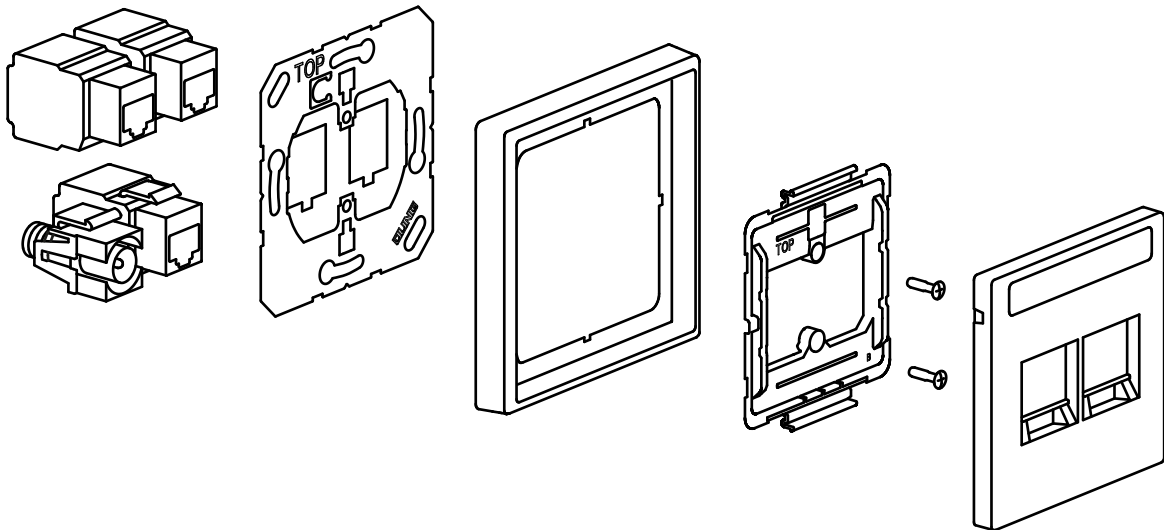

1

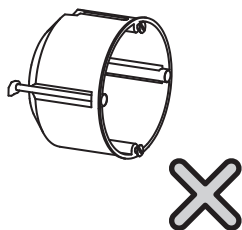
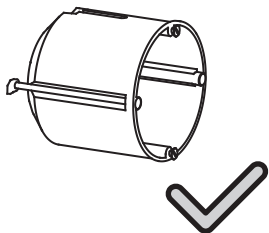

2

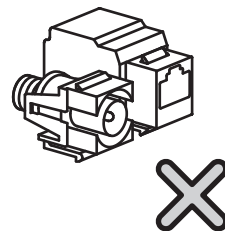
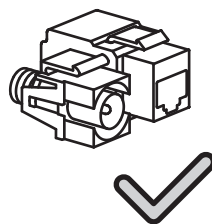
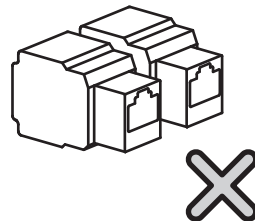
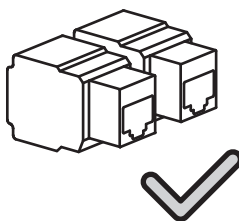

1

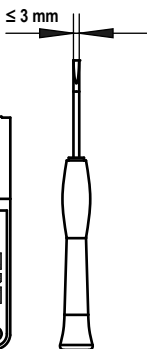
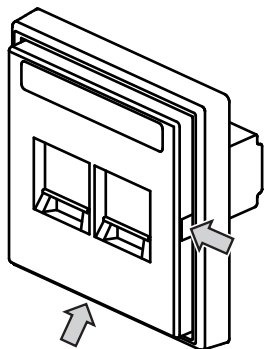

2

