

Product datasheet

Specifications



Miniature plug-in relay, 6 A, 4 CO, LED, 120 V AC

Local distributor code:

388198090

RXM4AB2F7

EAN Code: 3389119403849

Main

Range of product	Harmony Electromechanical Relays
Series name	RXM series
Product or component type	Plug-in relay
Relay type	Miniature relay
Contacts type and composition	4 C/O
status LED	With
Control type	Lockable test button
[Uc] control circuit voltage	120 V AC 50/60 Hz
[Ithe] conventional enclosed thermal current	6 A
Continuous output current	5 A

Complementary

[Uimp] rated impulse withstand voltage	2.5 kV during 1.2/50 μ s
[Ie] rated operational current	3 A at 28 V (DC) NC conforming to IEC 3 A at 250 V (AC) NC conforming to IEC 6 A at 28 V (DC) NO conforming to IEC 6 A at 250 V (AC) NO conforming to IEC 6 A at 277 V (AC) conforming to UL 8 A at 30 V (DC) conforming to UL
Minimum switching capacity	170 mW at 10 mA, 17 V
Electrical durability	100000 cycles for resistive load
Average coil consumption in VA	1.2 at 60 Hz
Rated operational voltage limits	96...132 V AC
[Ui] rated insulation voltage	250 V conforming to IEC 300 V conforming to CSA 300 V conforming to UL
Average consumption	1.2 VA at 60 Hz
Maximum switching voltage	250 V conforming to IEC
Drop-out voltage threshold	$\geq 0.15 U_c$
Load current	6 A at 250 V AC 6 A at 28 V DC
Operating time	20 ms
Maximum switching capacity	1500 VA/168 W
Average resistance	4430 Ohm at 20 °C +/- 15 %
Mechanical durability	10000000 cycles

Safety reliability data	B10d = 100000
Operating rate	<= 1200 cycles/hour under load <= 18000 cycles/hour no-load
Utilisation coefficient	20 %
CAD overall height	82.8 mm
CAD overall depth	80.35 mm
Reset time	20 ms
Dielectric strength	1300 V AC between contacts with micro disconnection 2000 V AC between coil and contact with basic insulation 2000 V AC between poles with basic insulation
Compatibility code	RXM
Protection category	RT I
Pollution degree	2
Operating position	Any position
Test levels	Level A group mounting
Device presentation	Complete product
Contacts material	AgNi
Shape of pin	Flat (faston type)
Product weight	0.037 kg

Environment

Ambient air temperature for operation	-40...55 °C
IP degree of protection	IP40 conforming to IEC 60529
Standards	CSA C22.2 No 14 UL 508 IEC 61810-1
Product certifications	UL Lloyd's CE CSA GOST IECEE CB Scheme
Ambient air temperature for storage	-40...85 °C
Vibration resistance	3 gn, amplitude = +/- 1 mm (f = 10...150 Hz)5 cycles in operation 5 gn, amplitude = +/- 1 mm (f = 10...150 Hz)5 cycles not operating
Shock resistance	10 gn for in operation 30 gn for not operating

Packing Units

Unit Type of Package 1	PCE
Number of Units in Package 1	1
Package 1 Height	2.100 cm
Package 1 Width	2.700 cm
Package 1 Length	4.800 cm
Package 1 Weight	34.000 g
Unit Type of Package 2	BB1
Number of Units in Package 2	10

Package 2 Height	3.100 cm
Package 2 Width	10.200 cm
Package 2 Length	12.700 cm
Package 2 Weight	369.000 g
Unit Type of Package 3	S02
Number of Units in Package 3	240
Package 3 Height	15.000 cm
Package 3 Width	30.000 cm
Package 3 Length	40.000 cm
Package 3 Weight	9.392 kg

Logistical informations

Country of origin CN

Contractual warranty

Warranty (in months) 18



Environmental Data

Schneider Electric aims to achieve Net Zero status by 2050 through supply chain partnerships, lower impact materials, and circularity via our ongoing “Use Better, Use Longer, Use Again” campaign to extend product lifetimes and recyclability.

[Environmental Data explained >](#)

[How we assess product sustainability >](#)



Environmental footprint

Total lifecycle Carbon footprint	22 kg CO2 eq.
Carbon footprint of the manufacturing phase [A1 to A3]	0.3 kg CO2 eq.
Carbon footprint of the distribution phase [A4]	0 kg CO2 eq.
Carbon footprint of the installation phase [A5]	0 kg CO2 eq.
Carbon footprint of the use phase [B2, B3, B4, B6]	22 kg CO2 eq.
Carbon footprint of the end-of-life phase [C1 to C4]	0 kg CO2 eq.
Environmental Disclosure	Product Environmental Profile

Use Better



Materials and Substances

Packaging made with recycled cardboard	Yes
Packaging without single use plastic	Yes
EU RoHS Directive	Compliant
REACH Regulation	Free of Substances of Very High Concern above the threshold

Use Longer



Lifetime extension

Repair	No
--------	----

Use Again



Repack and remanufacture

End of life manual availability	End of Life Information
Take-back	No

Dimensions Drawings

Dimensions

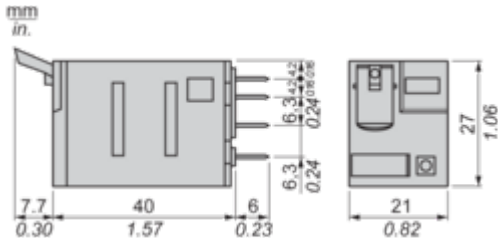

Pin Side View

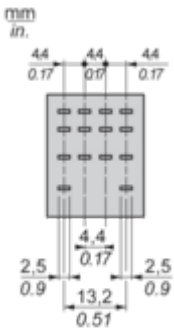

Connections and Schema

Wiring Diagram

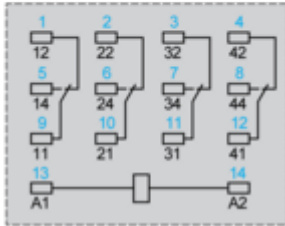
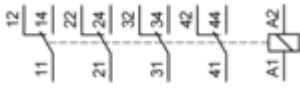

Symbols shown in blue correspond to Nema marking.

Performance Curves

Electrical Durability of Contacts

Durability (inductive load) = durability (resistive load) x reduction coefficient.

Resistive AC load

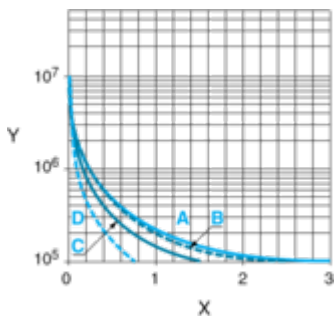

X Switching capacity (kVA)

Y Durability (Number of operating cycles)

A RXM2AB...

B RXM3AB...

C RXM4AB...

D RXM4GB...

Reduction coefficient for inductive AC load (depending on power factor $\cos \phi$)

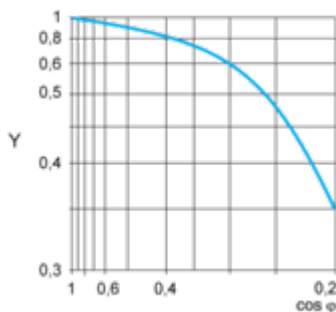

Y Reduction coefficient (A)

Maximum switching capacity on resistive DC load

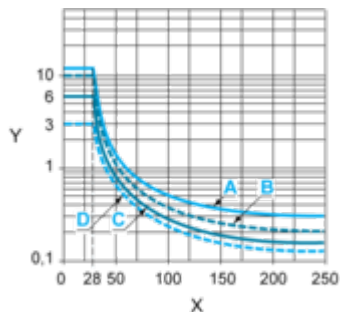

X Voltage DC

Y Current DC

A RXM2AB...

B RXM3AB...

C RXM4AB...

D RXM4GB...

Note : These are typical curves, actual durability depends on load, environment, duty cycle, etc.

For inductive load, to increase relay life cycles, please add a proper load protection circuit (eg: RC protection/Varistor/free Wheeling diode -DC load only-).

For low level loads (below 10mA), we recommend to use RXM*GB series with bifurcated contacts relays instead.

AC Coil Voltage and Operating Temperature under continuous duty

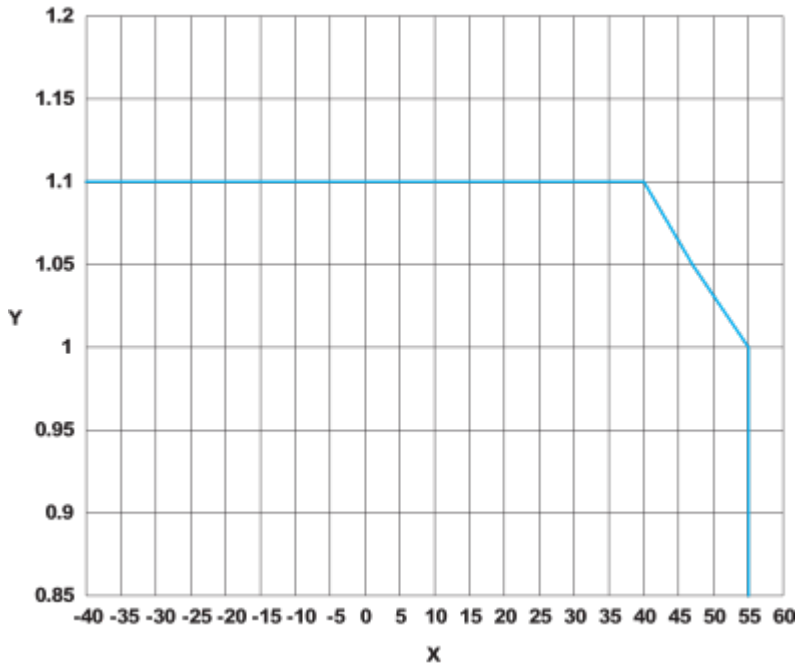

X : Operating temperature (°C)

Y : AC coil voltage (UC)

Technical Illustration

Dimensions

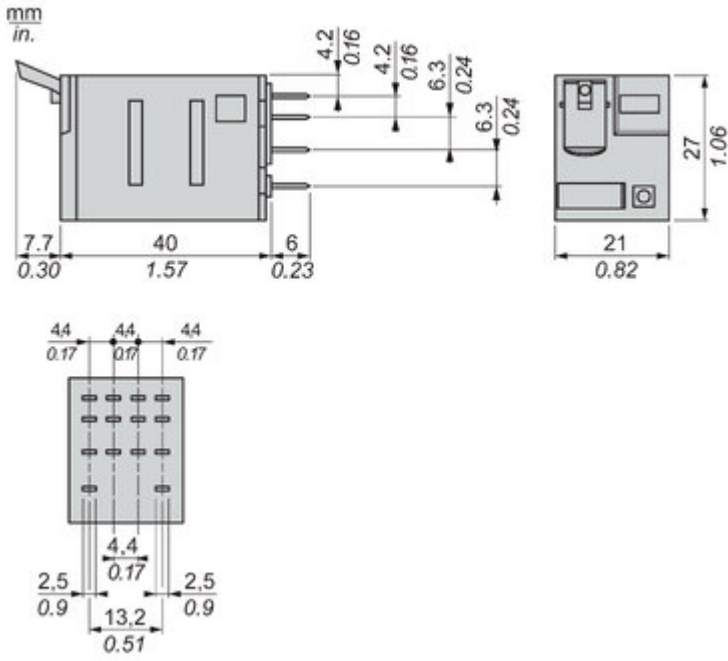

Offer Marketing Illustration

Product benefits / Features

Features

Harmony RXMAB Relay



Pluggable relay module for easy replacement and retrofitting of relays



Conforms to international standards: IEC, CE, UL, CSA, EAC, Lloyd's, RoHS and REACH





Save time and cost with pre-assembled relays and push-in sockets



Add-on protection modules and timer relay for flexibility

Offer Marketing Illustration

Product benefits / Features

Technical Benefits

Harmony RXMAB Relay

RXM*AB sockets:

- Mixed or separate contact arrangement
- Push-in, screw clamp or screw connector terminal

Plastic or metal maintaining clamp to protect against vibration

RXM*AB relays:

- 2CO-12A, 3CO-10A, 4CO-6A
- 12-220VDC, 24-240VAC

Push button (Blue for DC, Red for AC) and lockable test button for contact testing

Mechanical indicator for relay contact status

"Power On" LED for relay status

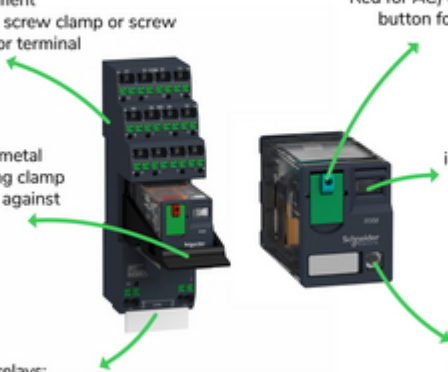

Image of product / Alternate images

Alternative





